

# MULTI-COLOR SPECIFICATION FOR SMD 2727WLE

## MC-S2727WLE

- FEATURES:**
- Size (mm):2.7×2.8×2.5
  - Surface not reflective
  - High reliability
  - Good UV resistance performance
  - Pb-free Reflow soldering Application
  - RoHS Compliant

## 1. SPECIFICATIONS

### 1.1 Absolute Maximum Ratings (Ta=25°C)

Item	Symbol	Absolute Maximum Rating			Unit
		Red	Green	Blue	
Forward Current	I <sub>F</sub>	30	30	30	mA
Pulse Forward Current	I <sub>FP</sub>	100	100	100	mA
Reverse Voltage	V <sub>R</sub>	5	5	5	V
Power dissipation	P <sub>D</sub>	62.4	99.9	100.5	mW
Operating Temperature	T <sub>opr</sub>	-30 to +85	-30 to +85	-30 to +85	°C
Storage Temperature	T <sub>stg</sub>	-40 to +100	-40 to +100	-40 to +100	°C

\* I<sub>FP</sub> conditions with pulse width ≤10ms and duty cycle ≤10%.

### 1.2 Optical and Electrical Characteristics (Ta=25°C)

Item	Symbol	Condition	Red		Green		Blue		Unit
			Min	Max	Min	Max	Min	Max	
Forward Voltage	V <sub>F</sub>	R I <sub>F</sub> =20mA G I <sub>F</sub> =15mA B I <sub>F</sub> =10mA	--	2.45	--	3.65	--	3.65	V
Reverse Current	I <sub>R</sub>	V <sub>R</sub> =5V	--	1	--	1	--	1	μA
Wavelength	λ <sub>D</sub>	R I <sub>F</sub> =20mA G I <sub>F</sub> =15mA B I <sub>F</sub> =10mA	615	630	515	535	460	480	nm
			3nm per Bin		3nm per Bin		3nm per Bin		
Luminous Intensity	I <sub>V</sub>	R I <sub>F</sub> =20mA G I <sub>F</sub> =15mA B I <sub>F</sub> =10mA	400	750	700	1400	100	300	mcd
			Typ. 550		Typ. 1100		Typ. 200		

\* Each Bin: I<sub>V</sub>(Max):I<sub>V</sub>(Min) ≤1.2.

\* Tolerance of measurements of the Forward Voltage is ±0.05V.

\* Tolerance of measurements of the Luminous Intensity is ±5%.

\* Tolerance of measurements of the Wavelength is ±0.5nm.

## 2. RELIABILITY

### 2.1 Test Items and Results

Test Item	Standard Test Method	Test Conditions	Test Duration	Units Failed/Tested
Resistance to Soldering Heat (Reflow Soldering)	JEITA ED-4701 300 301	Tsld=260°C,10sec. Precondition:30°C 70%RH,168hrs	2times	0/100
Temperature Cycle		-65°C~150°C 15min. 15min. (30min./cycle)	200cycles	0/100
Temperature Cycle	JEITA ED-4701 100 105	-40°C~25°C~100°C~25°C 30min. 5min. 30min. 5min	100cycles	0/100
Moisture Resistance (Cyclic)	JEITA ED-4701 200 203	25°C~65°C~-10°C 90%RH, 24hr per cycle	10cycles	0/100
High Temperature Storage	JEITA ED-4701 200 201	Ta=100°C	500hrs	0/100
Temperature Humidity Storage		Ta=85°C,RH=85%	500hrs	0/100
Low Temperature Storage	JEITA ED-4701 200 202	Ta=-40°C	500hrs	0/100
Room Temperature Operating Life		Ta=25°C, I <sub>F</sub> =15mA	1000hrs	0/10
Temperature Humidity Operating Life		Ta=85°C,RH=85% I <sub>F</sub> =15mA	500hrs	0/10
Low Temperature Operating Life		Ta=-30°C, I <sub>F</sub> =15mA	1000hrs	0/10

NOTES:

Measurements are performed after allowing the LEDs to return to room temperature.

### 2.2 Criteria for Judging Damage

Item	Symbol	Test Conditions	Criteria for Judgement	
			Min.	Max.
Forward Voltage	V <sub>F</sub>	I <sub>F</sub> = 20mA	-	U.S.L.×1.1
Reverse Current	I <sub>R</sub>	V <sub>R</sub> =5V	-	U.S.L.×2.0
Luminous Intensity	I <sub>V</sub>	I <sub>F</sub> =20mA	L.S.L. ×0.8	-

U.S.L.: Upper Standard Level

L.S.L.: Lower Standard Level

### 3. TYPICAL ELECTRICAL CHARACTERISTICS CURVES

All characteristics shown are for reference only and are not guaranteed.

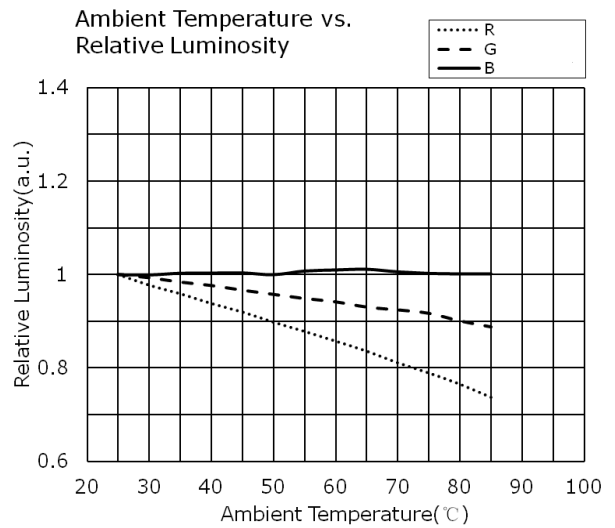
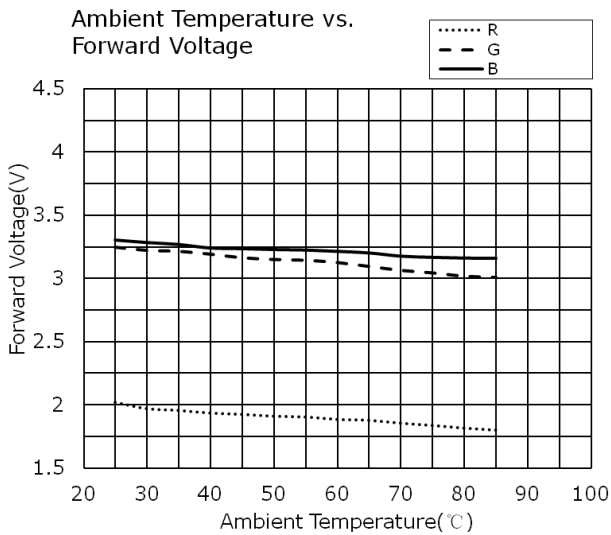
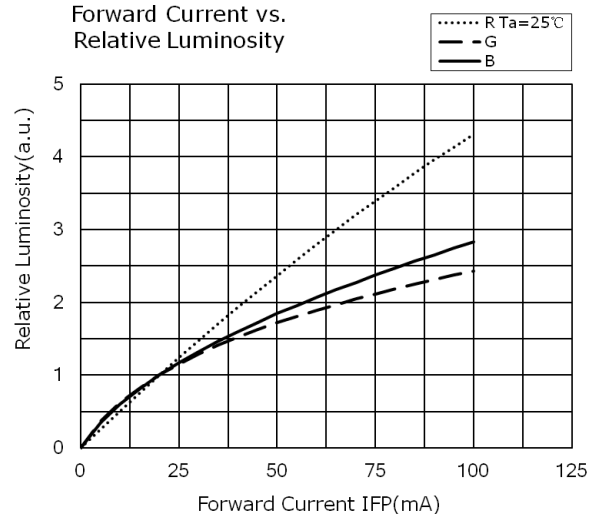
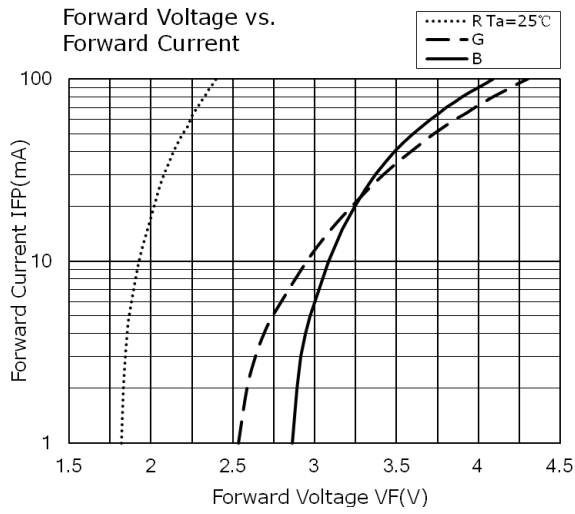

## 4. TYPICAL OPTICAL CHARACTERISTICS CURVES

All characteristics shown are for reference only and are not guaranteed.

Spectrum

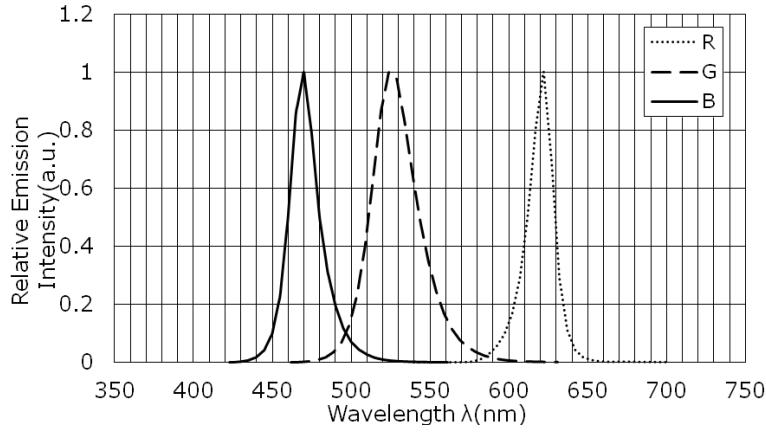

Directivity X-X

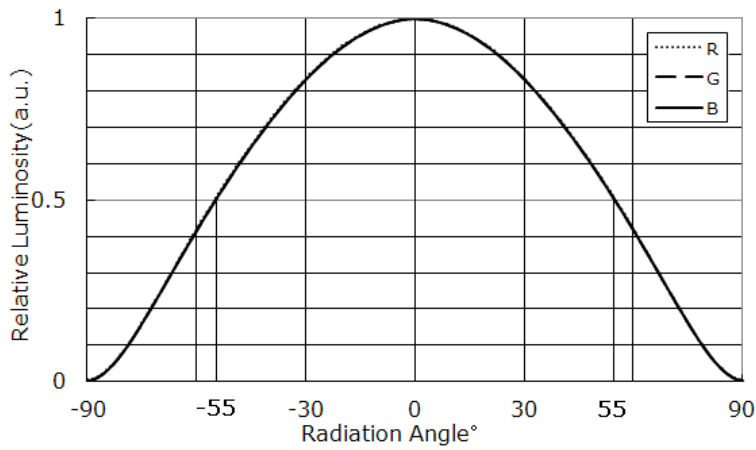

Directivity Y-Y

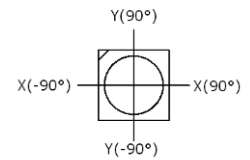
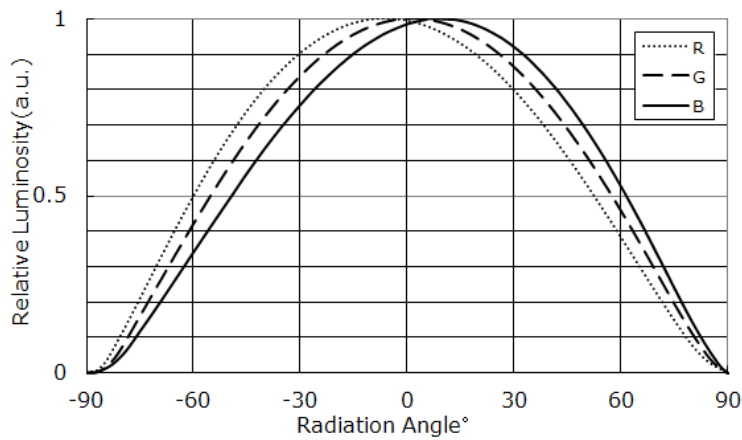

\* Monochromatic Relative Intensity Profile was controlled  $\leq \pm 10\%$

\* RGB Relative Intensity Profile was controlled  $\leq \pm 5\%$

## 5. OUTLINE DIMENSIONS AND MATERIALS

This product complies with RoHS Directive.

(Unit: mm, Tolerance:  $\pm 0.2$ )

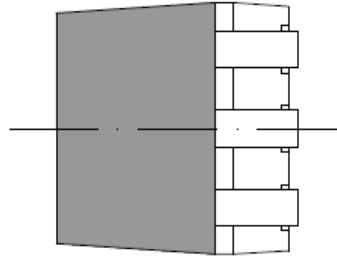
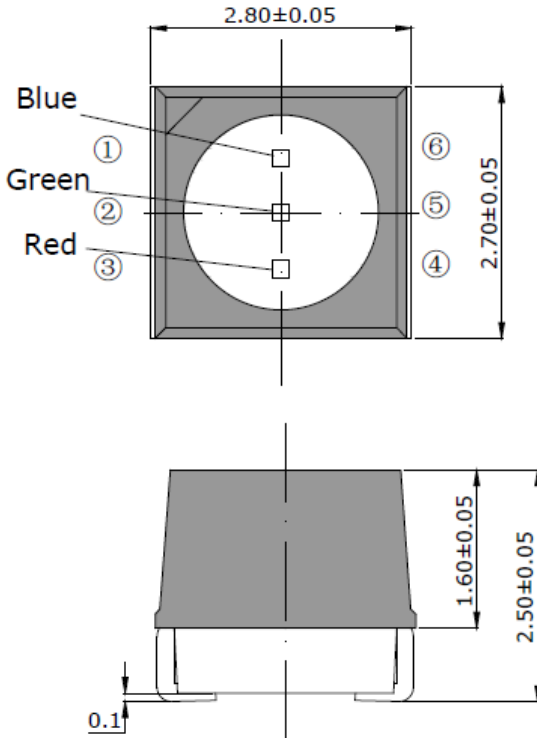

Item	Description
Package Materials	White Heat-Resistant Polymer
Package Upper Surface Color	Black
Encapsulating Resin Materials	Epoxy Resin(With diffuser)
Electrodes Materials	Ag-plated Copper Alloy

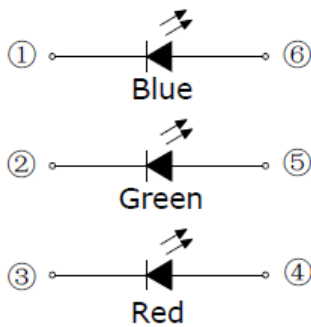
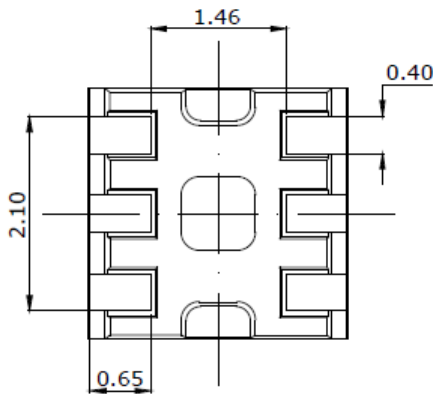

## 6. SOLDERING

- Recommended Reflow Soldering Condition(Lead-free Solder)

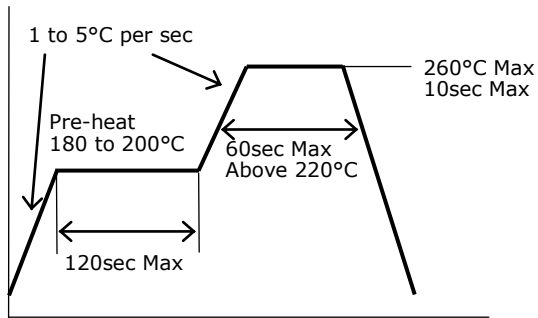

- Recommended Hand Soldering Condition

Temperature	350°C Max
Soldering Time	3sec Max

- Recommended Soldering Pad Pattern

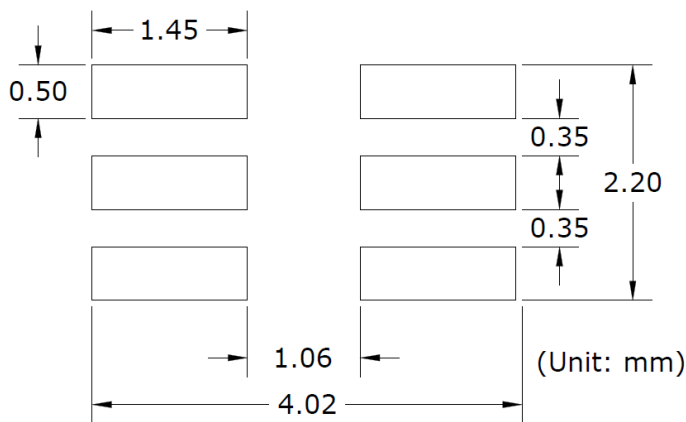

- \* This LED is designed to be reflow soldered on to a PCB. If dip soldered, Multi Color cannot guarantee its reliability.
- \* Reflow soldering must not be performed more than twice. Hand soldering must not be performed more than once.
- \* Avoid rapid cooling. Ramp down the temperature gradually from the peak temperature.
- \* Nitrogen reflow soldering is recommended. Air flow soldering conditions can cause optical degradation, caused by heat and/or atmosphere.
- \* Repairing should not be done after the LEDs have been soldered. When repairing is unavoidable, a double-heat soldering iron should be used.

It should be confirmed beforehand whether the characteristics of the LEDs will or will not be damaged by repairing.

- \* When soldering, do not apply stress to the LED while the LED is hot.
  - \* This product can differ in optical characteristics depending on the number of reflow cycles.
- In a single display, only LEDs with same number of reflow cycles should be used regardless of the application type, such as rental and/or permanent installations.

## 7. TAPE AND REEL DIMENSIONS

Tape:

(Unit: mm)

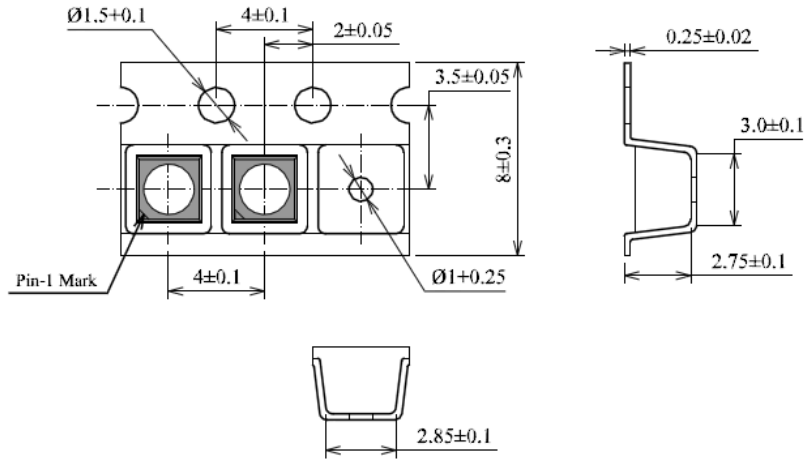

Trailer and Leader:

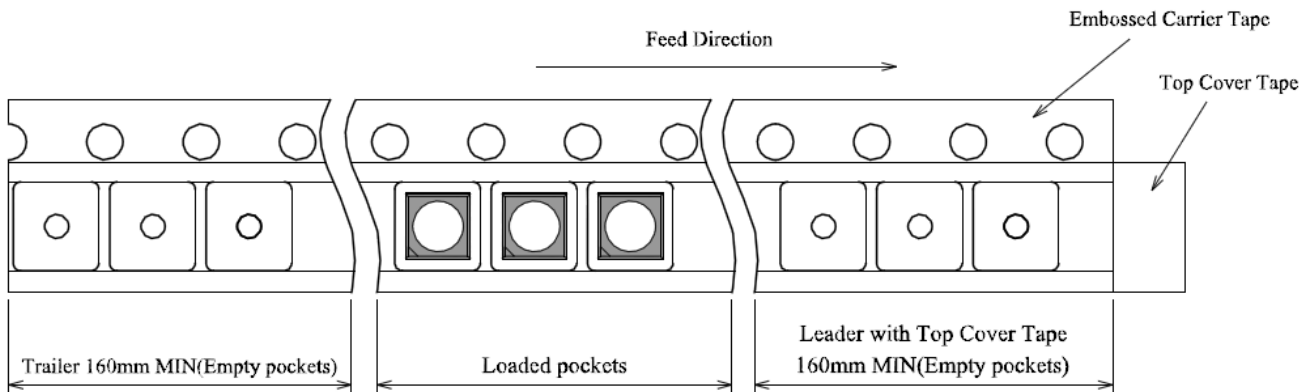

Reel:

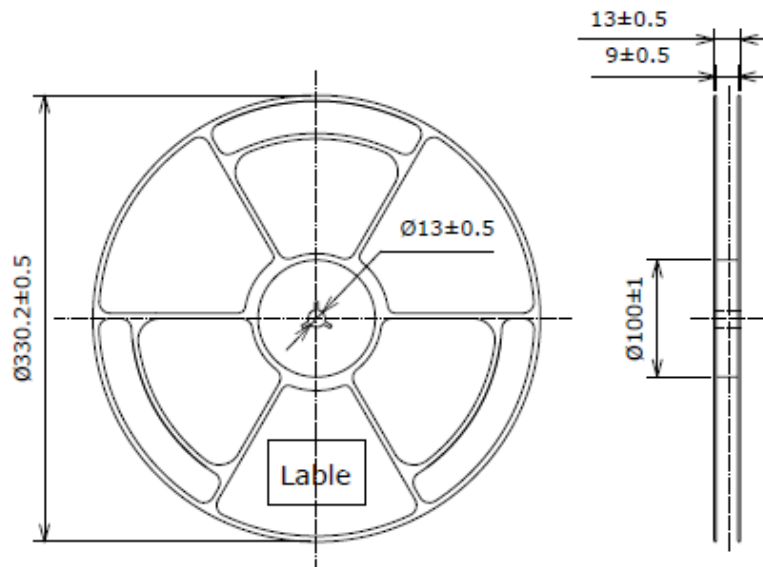

Quantity per reel=5000pcs



## 8. PACKAGING – TAPE & REEL

Reels are shipped with desiccants in heat-sealed inner moisture-proof bags.

Inner moisture-proof bags are shipped in heat-sealed outer moisture-proof bags.

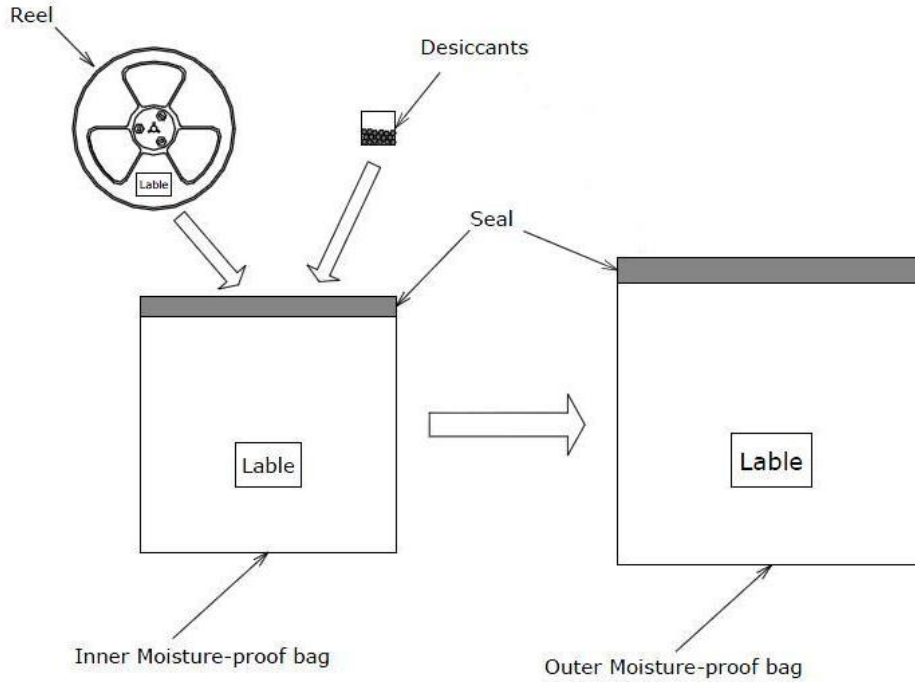

Outer moisture-proof bags are packed in cardboard boxes with corrugated partitions.

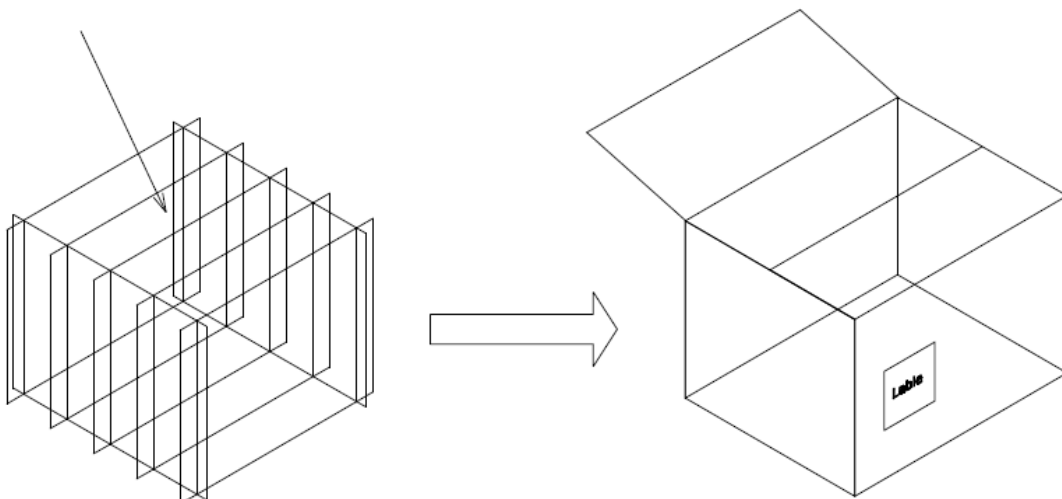

\* The Label shows: P/O NO., TYPE, QTY, IV, VF, WLD, BATCH CODE.

\* Products shipped on tape and reel are packed in moisture-proof bag.

They are shipped in cardboard boxes to protect them from external forces during transportation.

\* Do not drop or shock the box. It may damage the products.

\* Do not expose to water, the box is not water-resistant.

\* Using an original packaging material or equivalent in transit is recommended.

---

## 9. STORAGE CONDITIONS

- Before opening the package, must check if the package bag is well packaged or damaged.

If the package is damaged, please return back to Multi-Color.

- After opening the package:

After this bag is opened, devices that will be subjected to infrared reflow, vapor-phase reflow, or equivalent processing

Must be:

- a) Mounted within 24 hours at factory condition of  $\leq 30^{\circ}\text{C}$  /60%RH.
- b) If unused LEDs remain, please return these LEDs back to Multi-Color.

- The LEDs must be used within 6 months.

The LEDs should be kept at less than  $30^{\circ}\text{C}$  and less than 60%RH.

## 10. STATIC ELECTRICITY

- Static electricity or surge voltage damages the LEDs.

It is recommended that a wrist band or an anti-electrostatic glove be used when handling the LEDs.

- All devices equipment and machinery must be properly grounded. It is recommended that precautions be taken against surge voltage to the equipment that mounts the LEDs.