

MULTI-COLOR SPECIFICATION FOR SMD 2121BHA

MC-S2121BHA

- FEATURES:**
- Size (mm): 2.1×2.1×1.1
 - Surface not reflective
 - Pb-free Reflow soldering Application
 - RoHS Compliant

1. SPECIFICATIONS

1.1 Absolute Maximum Ratings (Ta=25°C)

Item	Symbol	Absolute Maximum Rating			Unit
		Red	Green	Blue	
Forward Current	I_F	30	20	20	mA
Pulse Forward Current	I_{FP}	100	100	100	mA
Reverse Voltage	V_R	5	5	5	V
Power dissipation	P_D	66.3	68	68	mW
Operating Temperature	T_{opr}	-30 to +85	-30 to +85	-30 to +85	°C
Storage Temperature	T_{stg}	-40 to +100	-40 to +100	-40 to +100	°C

* I_{FP} conditions with pulse width $\leq 10\text{ms}$ and duty cycle $\leq 10\%$.

1.2 Optical and Electrical Characteristics (Ta=25°C)

Item	Symbol	Condition	Red		Green		Blue		Unit
			Min	Max	Min	Max	Min	Max	
Forward Voltage	V_F	R $I_F=20\text{mA}$ G $I_F=15\text{mA}$ B $I_F=10\text{mA}$	-	2.45	-	3.55	-	3.45	V
Reverse Current	I_R	$V_R=5\text{V}$	--	1	--	1	--	1	μA
Wavelength	λ_D	R $I_F=20\text{mA}$ G $I_F=15\text{mA}$ B $I_F=10\text{mA}$	615	630	515	535	460	480	nm
			3nm per Bin		3nm per Bin		3nm per Bin		
Luminous Intensity	I_V	R $I_F=20\text{mA}$ G $I_F=15\text{mA}$ B $I_F=10\text{mA}$	200	500	300	600	50	80	mcd
			Typ.340		Typ.430		Typ.65		

* A: Not Reflective Surface.

* Each Bin: $I_V(\text{Max}):I_V(\text{Min}) \leq 1.2$.

* Tolerance of measurements of the Forward Voltage is $\pm 0.05\text{V}$.

* Tolerance of measurements of the Luminous Intensity is $\pm 5\%$.

* Tolerance of measurements of the Wavelength is $\pm 0.5\text{nm}$.

2. RELIABILITY

2.1 Test Items and Results

Test Item	Standard Test Method	Test Conditions	Test Duration	Units Failed/Tested
Resistance to Soldering Heat (Reflow Soldering)	JEITA ED-4701 300 301	Tsld=260°C,10sec. Precondition:30°C 70%RH,168hrs	2times	0/100
Temperature Cycle		-65°C~150°C 15min. 15min. (30min./cycle)	200cycles	0/100
Temperature Cycle	JEITA ED-4701 100 105	-40°C~25°C~100°C~25°C 30min. 5min. 30min. 5min	100cycles	0/100
Moisture Resistance (Cyclic)	JEITA ED-4701 200 203	25°C~65°C~-10°C 90%RH, 24hr per cycle	10cycles	0/100
High Temperature Storage	JEITA ED-4701 200 201	Ta=100°C	500hrs	0/100
Temperature Humidity Storage		Ta=85°C,RH=85%	500hrs	0/100
Low Temperature Storage	JEITA ED-4701 200 202	Ta=-40°C	500hrs	0/100
Room Temperature Operating Life		Ta=25°C, I _F =15mA	1000hrs	0/10
Temperature Humidity Operating Life		Ta=85°C,RH=85% I _F =15mA	500hrs	0/10
Low Temperature Operating Life		Ta=-30°C, I _F =15mA	1000hrs	0/10

NOTES:

Measurements are performed after allowing the LEDs to return to room temperature.

2.2 Criteria for Judging Damage

Item	Symbol	Test Conditions	Criteria for Judgement	
			Min.	Max.
Forward Voltage	V _F	R I _F =20mA G I _F =15mA B I _F =10mA	-	U.S.L.×1.1
Reverse Current	I _R	V _R =5V	-	U.S.L.×2.0
Luminous Intensity	I _v	R I _F =20mA G I _F =15mA B I _F =10mA	L.S.L. ×0.8	-

U.S.L.: Upper Standard Level

L.S.L.: Lower Standard Level

3. TYPICAL ELECTRICAL CHARACTERISTICS CURVES

All characteristics shown are for reference only and are not guaranteed.

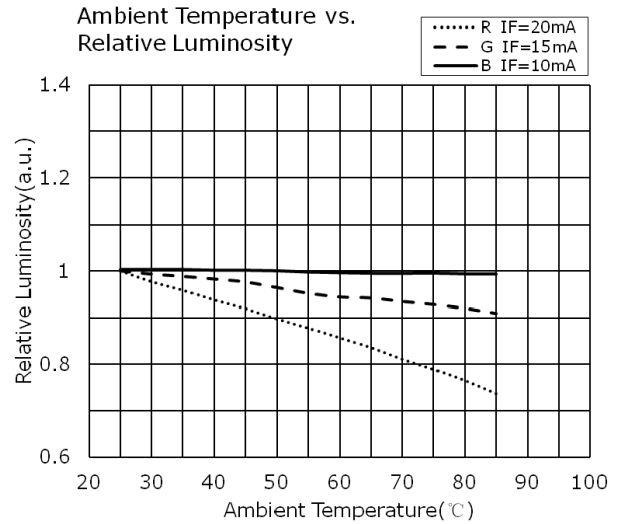
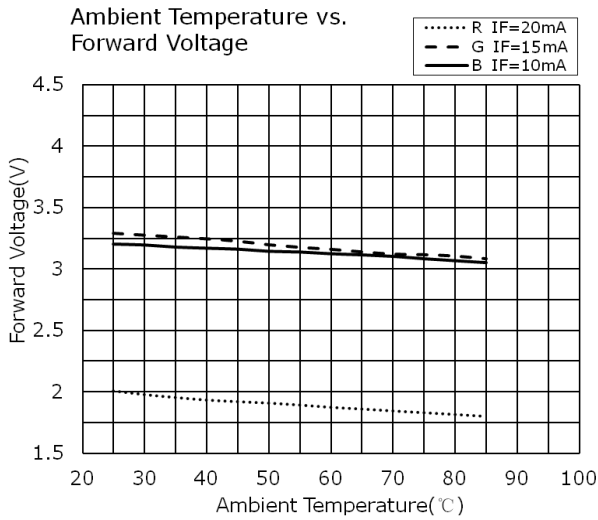
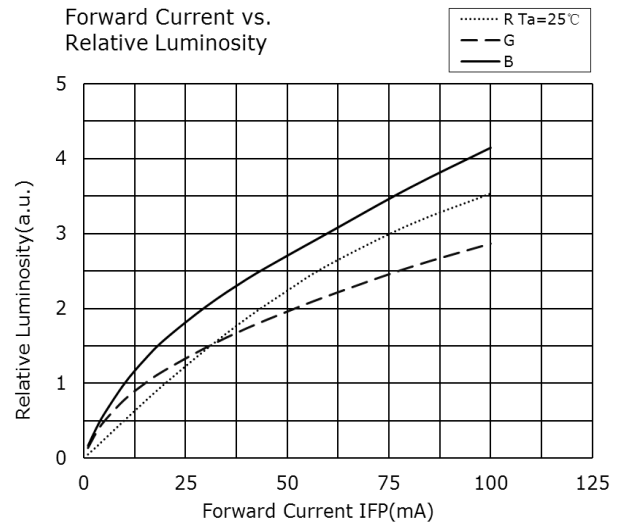
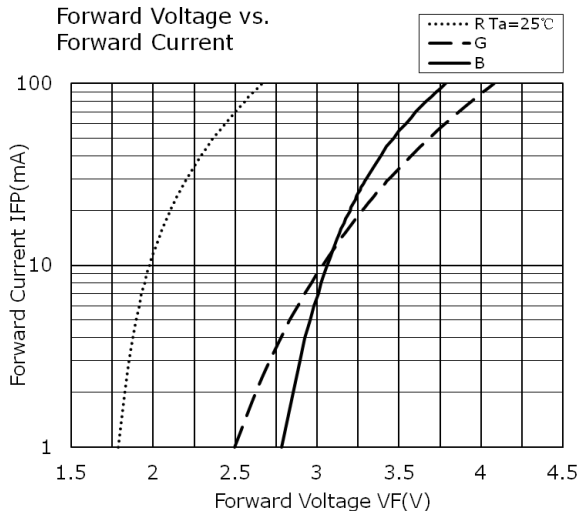

4. TYPICAL OPTICAL CHARACTERISTICS CURVES

All characteristics shown are for reference only and are not guaranteed.

Spectrum

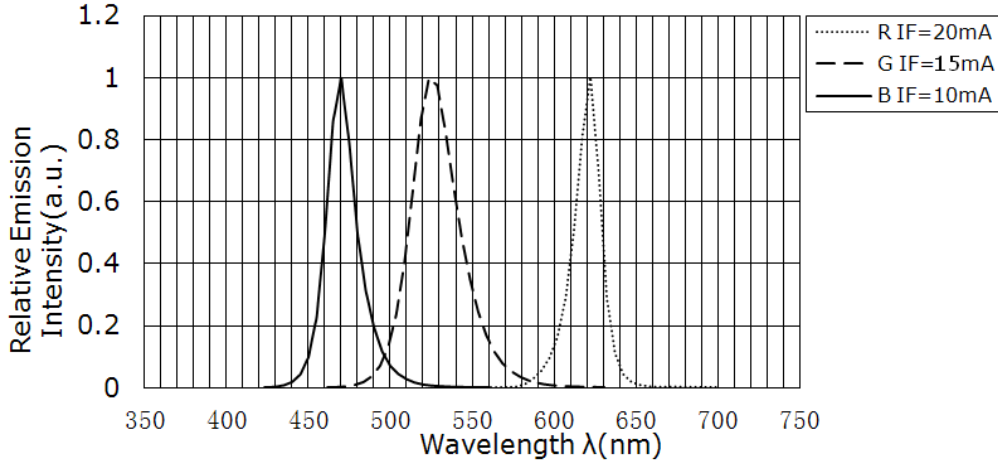

Directivity X-X

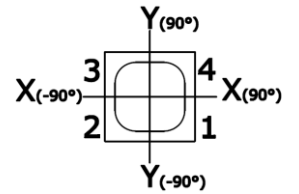
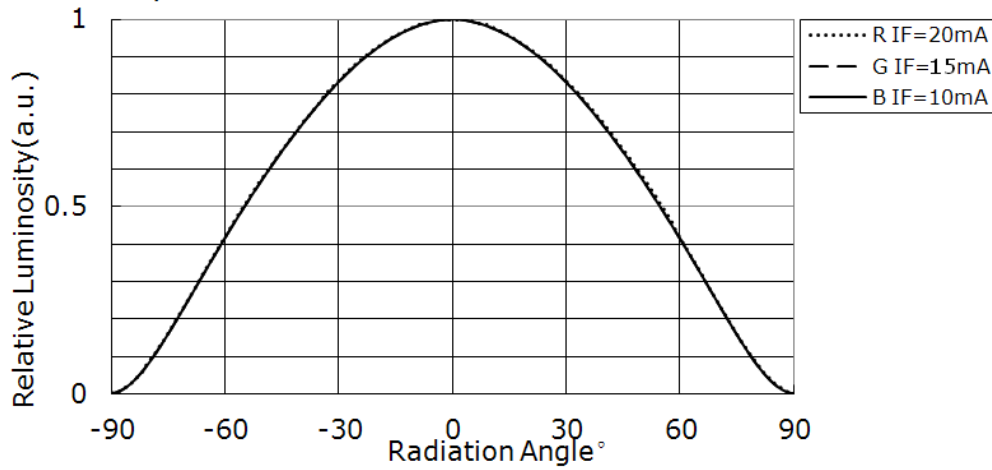

Directivity Y-Y

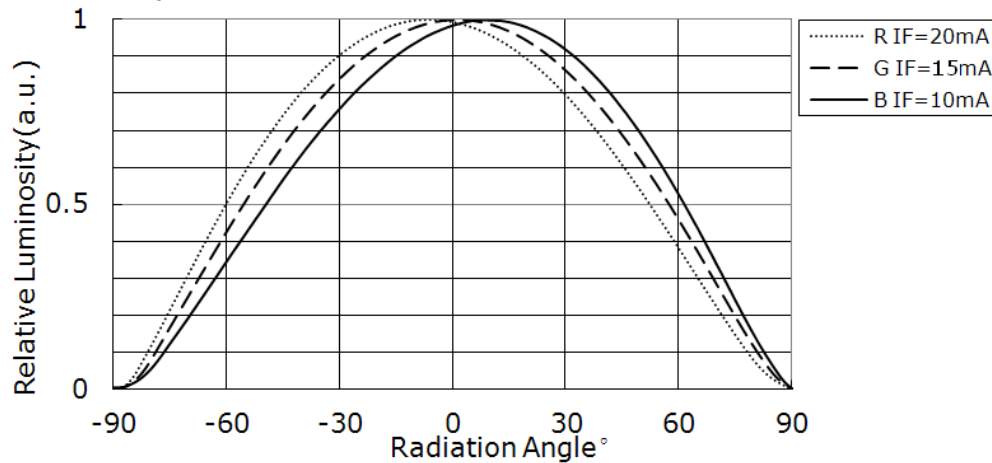

5. OUTLINE DIMENSIONS AND MATERIALS

This product complies with RoHS Directive.

(Unit: mm, Tolerance: ± 0.2)

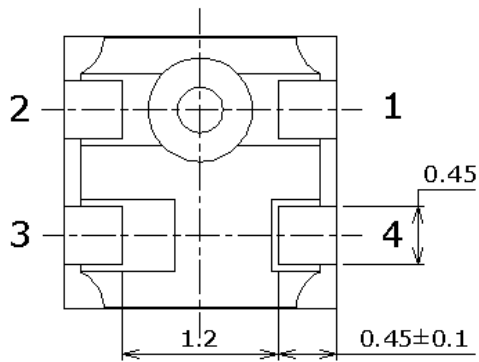
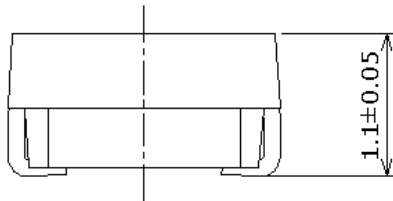
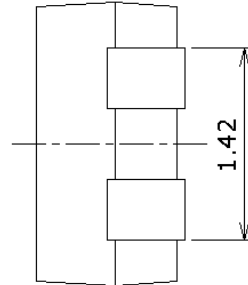
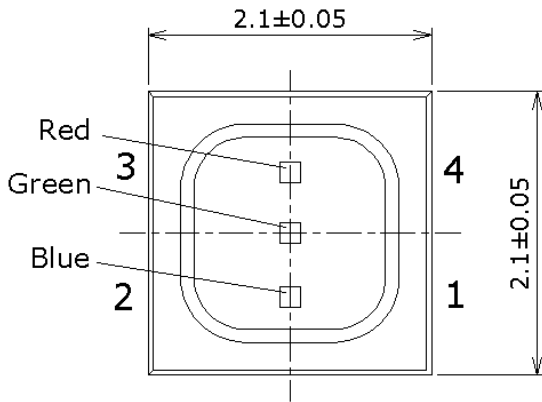

Item	Description
Package Materials	Black Heat-Resistant Polymer
Package Upper Surface Color	Black
Encapsulating Resin Materials	Epoxy Resin(With diffuser)
Electrodes Materials	Ag-plated Copper Alloy

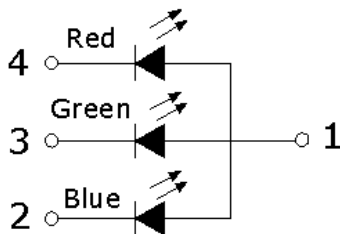

6. SOLDERING

• Recommended Reflow Soldering Condition(Lead-free Solder)

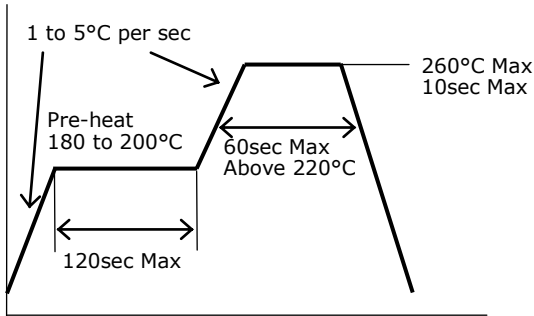

• Recommended Hand Soldering Condition

Temperature	350°C Max
Soldering Time	3sec Max

• Recommended Soldering Pad Pattern

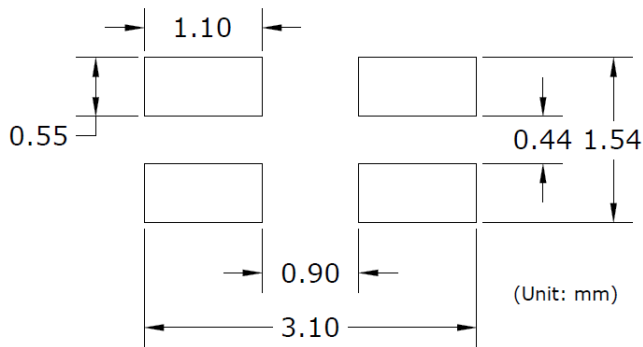

- * This LED is designed to be reflow soldered on to a PCB. If dip soldered, Multi Color cannot guarantee its reliability.
- * Reflow soldering must not be performed more than twice. Hand soldering must not be performed more than once.
- * Avoid rapid cooling. Ramp down the temperature gradually from the peak temperature.
- * Nitrogen reflow soldering is recommended. Air flow soldering conditions can cause optical degradation, caused by heat and/or atmosphere.
- * Repairing should not be done after the LEDs have been soldered. When repairing is unavoidable, a double-heat soldering iron should be used.

It should be confirmed beforehand whether the characteristics of the LEDs will or will not be damaged by repairing.

- * When soldering, do not apply stress to the LED while the LED is hot.
- * This product can differ in optical characteristics depending on the number of reflow cycles.

In a single display, only LEDs with same number of reflow cycles should be used regardless of the application type, such as rental and/or permanent installations.

8. PACKAGING – TAPE & REEL

Reels are shipped with desiccants in heat-sealed inner moisture-proof bags.

Inner moisture-proof bags are shipped in heat-sealed outer moisture-proof bags.

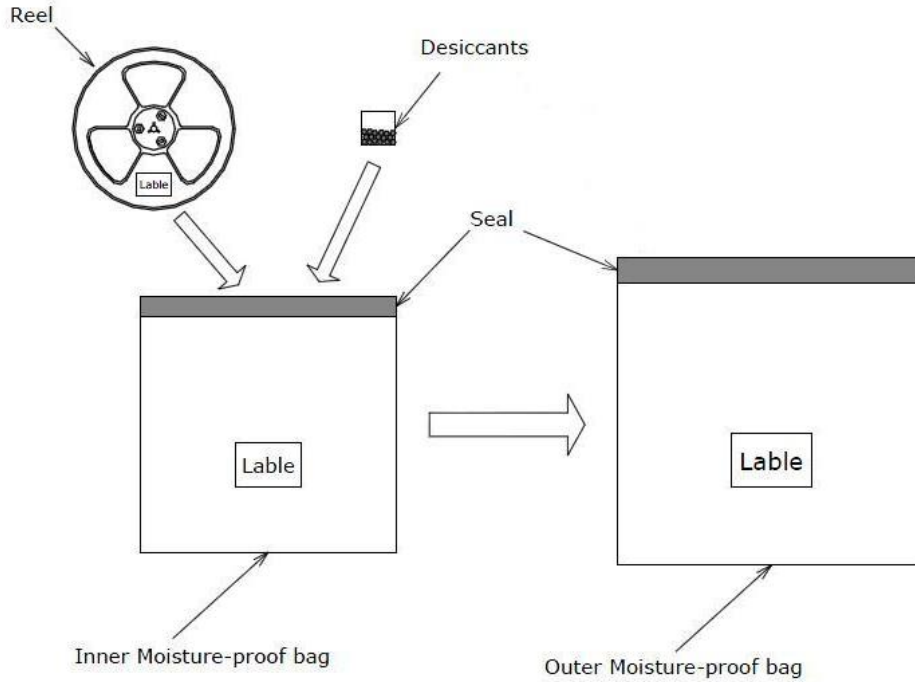

Outer moisture-proof bags are packed in cardboard boxes with corrugated partitions.

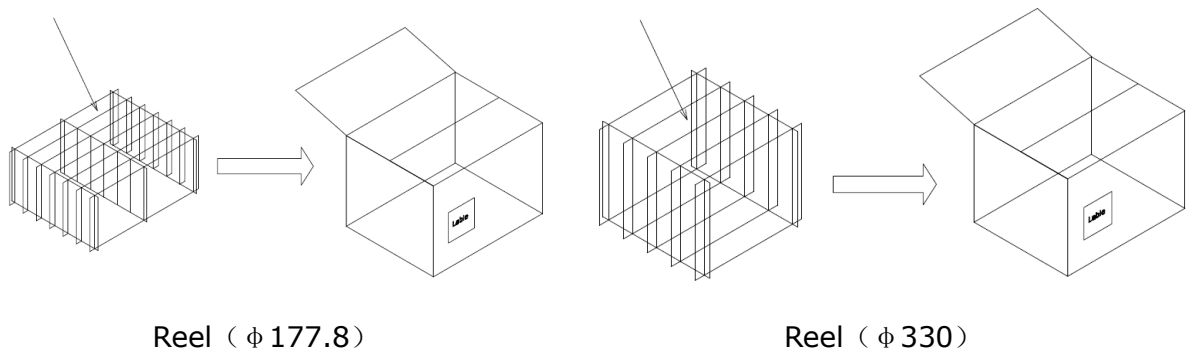

* The Label shows: P/O NO., TYPE, QTY, IV, VF, WLD.

* Products shipped on tape and reel are packed in moisture-proof bag.

They are shipped in cardboard boxes to protect them from external forces during transportation.

* Do not drop or shock the box. It may damage the products.

* Do not expose to water, the box is not water-resistant.

* Using an original packaging material or equivalent in transit is recommended.

9. STORAGE CONDITIONS

- Before opening the package, must check if the package bag is well packaged or damaged.

If the package is damaged, please return back to Multi-Color.

- After opening the package:

After this bag is opened, devices that will be subjected to infrared reflow, vapor-phase reflow, or equivalent processing
Must be:

- a) Mounted within 24 hours at factory condition of $\leq 30^{\circ}\text{C}$ /60%RH.
- b) If unused LEDs remain, please return these LEDs back to Multi-Color.

- The LEDs must be used within 6 months.

The LEDs should be kept at less than 30°C and less than 60%RH.

10. STATIC ELECTRICITY

- Static electricity or surge voltage damages the LEDs.

It is recommended that a wrist band or an anti-electrostatic glove be used when handing the LEDs.

- All devices equipment and machinery must be properly grounded. It is recommended that precautions be taken against surge voltage to the equipment that mounts the LEDs.