

SMD 3030 Black Frame MC-S3030BHA

1. SPECIFICATIONS

1.1 Absolute Maximum Ratings (Ta=25°C)

Item	Symbol	Absolute Maximum Rating			Unit
		Red	Green	Blue	
Forward Current	I _F	30	30	30	mA
Pulse Forward Current	I _{FP}	100	100	100	mA
Reverse Voltage	V _R	5	5	5	V
Power dissipation	P _D	66.3	99.6	99.6	mW
Operating Temperature	T _{opr}	-30 to +85	-30 to +85	-30 to +85	°C
Storage Temperature	T _{stg}	-40 to +100	-40 to +100	-40 to +100	°C

* I_{FP} conditions with pulse width ≤10ms and duty cycle ≤10%.

1.2 Optical and Electrical Characteristics (Ta=25°C)

Item	Symbol	Condition	Red		Green		Blue		Unit
			Min	Max	Min	Max	Min	Max	
Forward Voltage	V _F	I _F =20mA	1.75	2.45	2.75	3.65	2.75	3.65	V
Reverse Current	I _R	V _R =5V	--	1	--	1	--	1	μA
Wavelength	λ _D	I _F =20mA	618	627	521	530	465	474	nm
			3nm per Bin		3nm per Bin		3nm per Bin		
Luminous Intensity	I _V	I _F =20mA	215	350	365	680	80	140	mcd
			Typ.300		Typ.600		Typ.110		

* A: Not Reflective Surface.

* Each Bin: I_V(Max):I_V(Min) ≤1.2.

* Tolerance of measurements of the Forward Voltage is ±0.05V.

* Tolerance of measurements of the Luminous Intensity is ±5%.

* Tolerance of measurements of the Wavelength is ±0.5nm.

2. RELIABILITY

2.1 Test Items and Results

Test Item	Standard Test Method	Test Conditions	Test Duration	Units Failed/Tested
Resistance to Soldering Heat (Reflow Soldering)	JEITA ED-4701 300 301	Tsld=260°C,10sec. Precondition:30°C 70%RH,168hrs	2times	0/100
Temperature Cycle		-65°C~150°C 15min. 15min. (30min./cycle)	200cycles	0/100
Temperature Cycle	JEITA ED-4701 100 105	-40°C~25°C~100°C~25°C 30min. 5min. 30min. 5min	100cycles	0/100
Moisture Resistance (Cyclic)	JEITA ED-4701 200 203	25°C~65°C~-10°C 90%RH, 24hr per cycle	10cycles	0/100
High Temperature Storage	JEITA ED-4701 200 201	Ta=100°C	500hrs	0/100
Temperature Humidity Storage		Ta=85°C,RH=85%	500hrs	0/100
Low Temperature Storage	JEITA ED-4701 200 202	Ta=-40°C	500hrs	0/100
Room Temperature Operating Life		Ta=25°C, I _F =15mA	1000hrs	0/10
Temperature Humidity Operating Life		Ta=85°C,RH=85% I _F =15mA	500hrs	0/10
Low Temperature Operating Life		Ta=-30°C, I _F =15mA	1000hrs	0/10

NOTES:

Measurements are performed after allowing the LEDs to return to room temperature.

2.2 Criteria for Judging Damage

Item	Symbol	Test Conditions	Criteria for Judgement	
			Min.	Max.
Forward Voltage	V _F	I _F =20mA	-	U.S.L. ×1.1
Reverse Current	I _R	V _R =5V	-	U.S.L. ×2.0
Luminous Intensity	I _V	I _F =20mA	L.S.L. ×0.8	-

U.S.L.: Upper Standard Level

L.S.L.: Lower Standard Level

3. TYPICAL ELECTRICAL CHARACTERISTICS CURVES

All characteristics shown are for reference only and are not guaranteed.

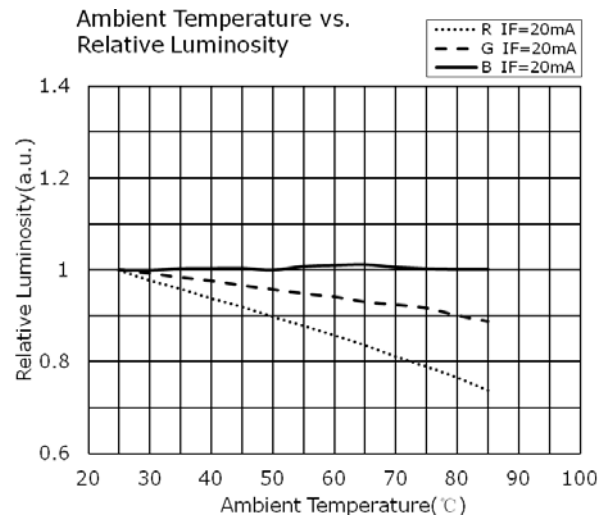
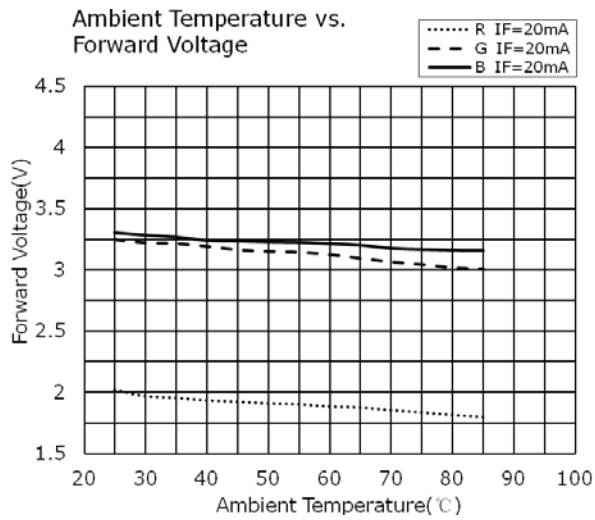
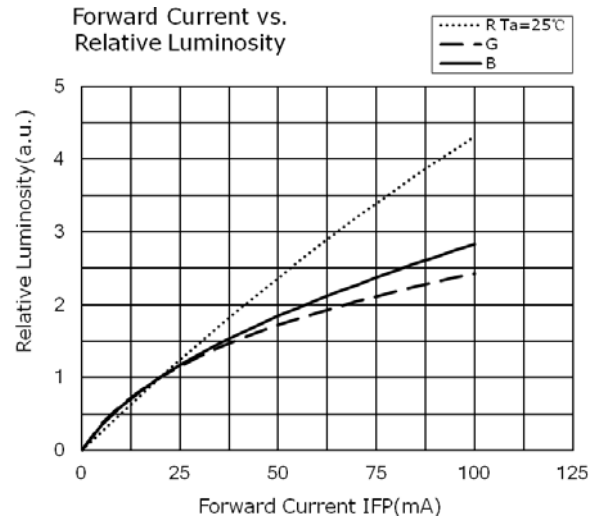
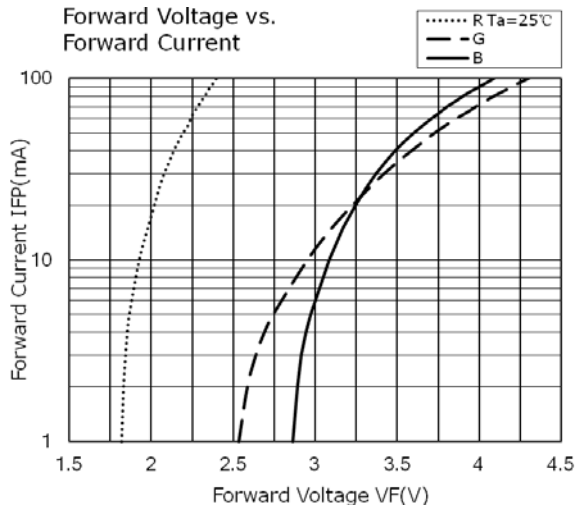

4. TYPICAL OPTICAL CHARACTERISTICS CURVES

All characteristics shown are for reference only and are not guaranteed.

Spectrum

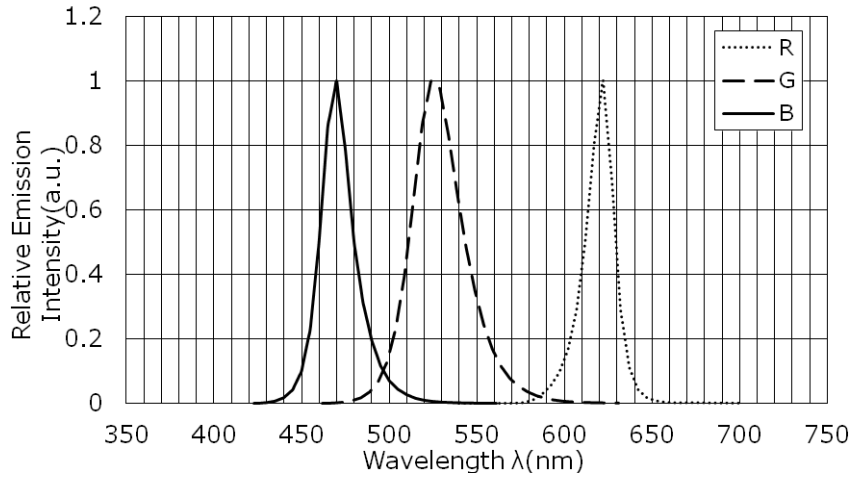

Directivity X-X

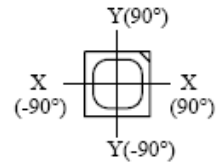
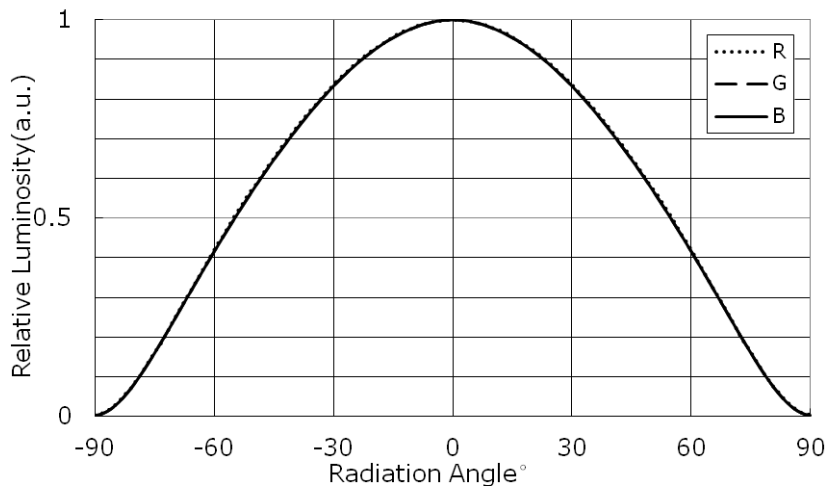

Directivity Y-Y

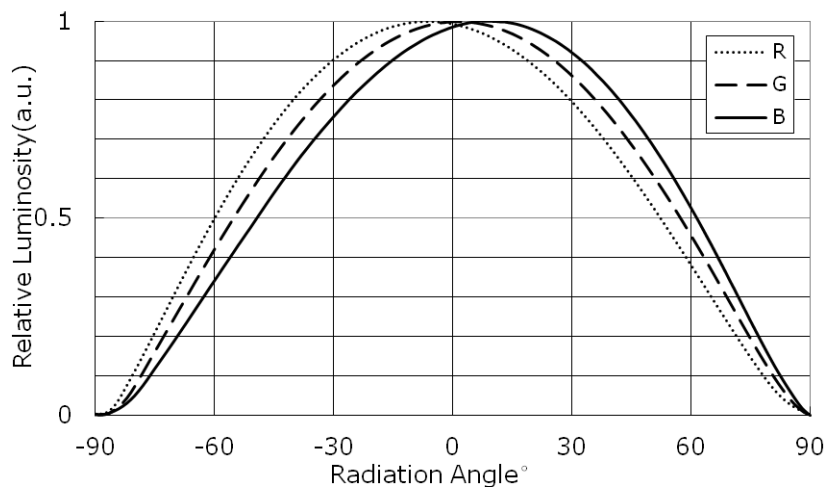

5. OUTLINE DIMENSIONS AND MATERIALS

This product complies with RoHS Directive.

(Unit: mm, Tolerance: ± 0.2)

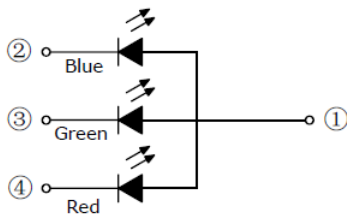
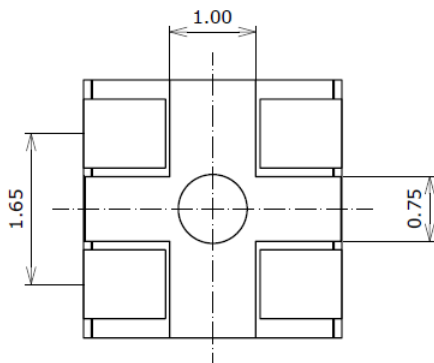
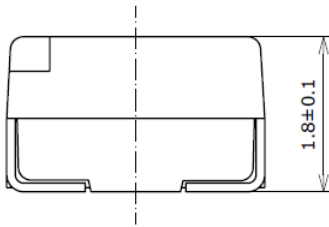
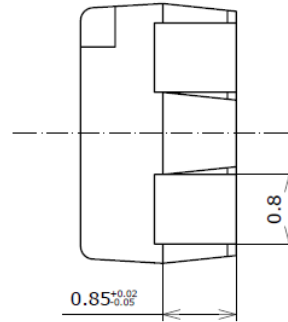
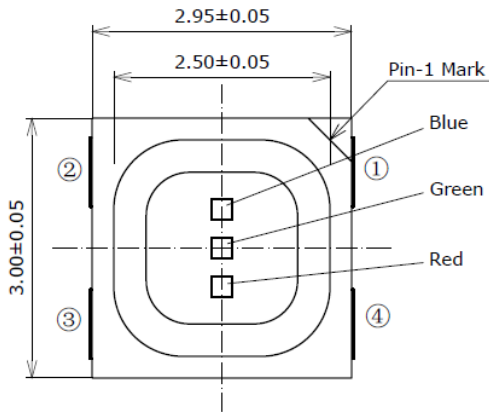

Item	Description
Package Materials	Black Heat-Resistant Polymer
Package Upper Surface Color	Black
Encapsulating Resin Materials	Epoxy Resin(With diffuser)
Electrodes Materials	Ag-plated Copper Alloy

7. PACKAGING – TAPE & REEL

Reels are shipped with desiccants in heat-sealed inner moisture-proof bags.

Inner moisture-proof bags are shipped with desiccants in heat-sealed outer moisture-proof bags.

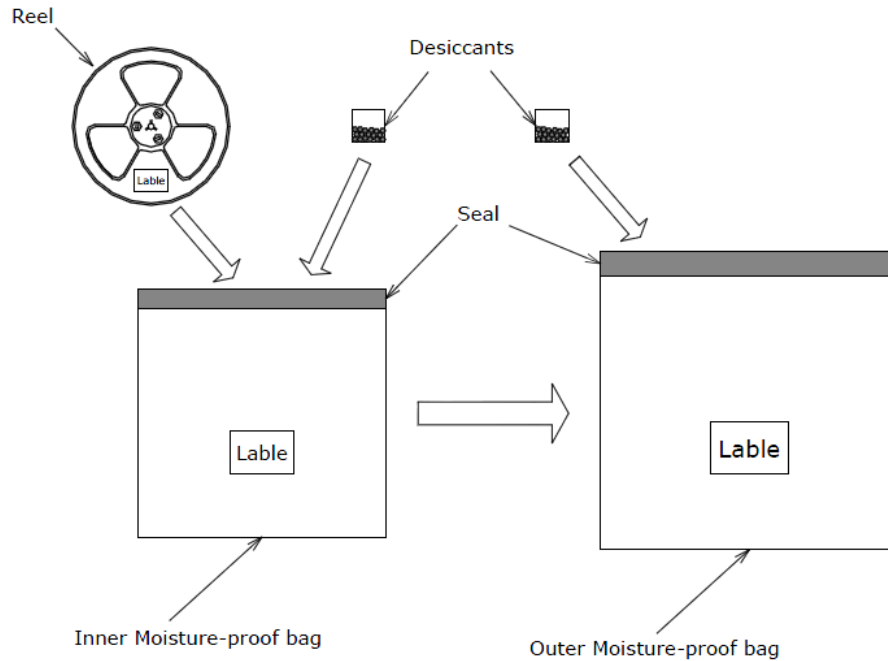

Outer moisture-proof bags are packed in cardboard boxes with corrugated partitions.

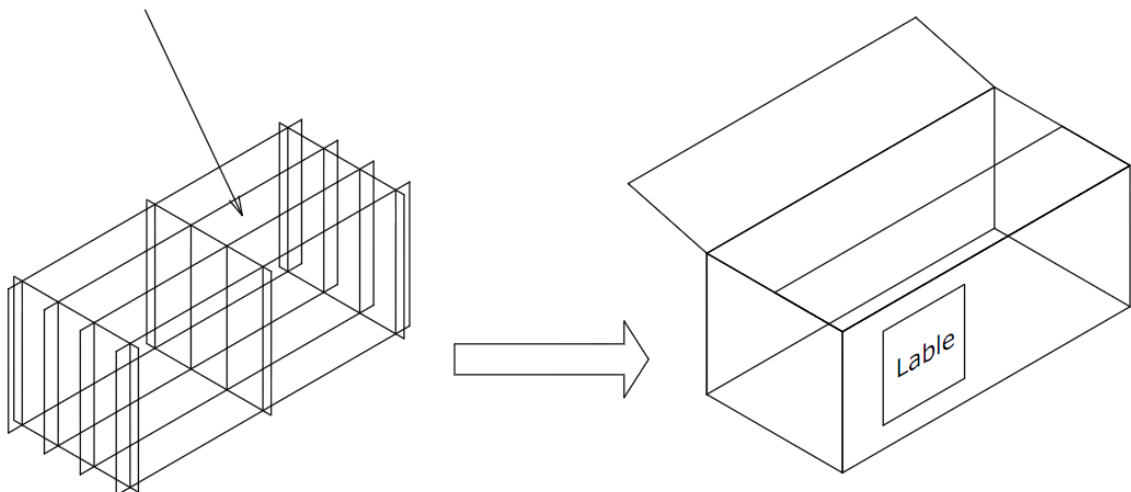

* The Label shows: P/O NO., TYPE, QTY, IV, VF, WLD.

* Products shipped on tape and reel are packed in moisture-proof bag.

They are shipped in cardboard boxes to protect them from external forces during transportation.

* Do not drop or shock the box. It may damage the products.

* Do not expose to water, the box is not water-resistant.

* Using an original packaging material or equivalent in transit is recommended.

8. MOISTURE PROOF PACKAGE

- When moisture is absorbed into the SMT package it may vaporize and expand during soldering. There is a possibility that this can cause exfoliation of the contacts and damage the optical characteristics of the LEDs. For this reason, the moisture proof package is used to keep moisture to a minimum in the package.
- The moisture proof package is made absorbent material (silica gel desiccants) is inserted into the aluminium moisture proof bag.
- The silica gel desiccants change from blue to red if moisture had penetrated bags.

9. STORAGE CONDITIONS

- Storage Conditions

Before opening the package:

The LEDs should be kept at 30°C or less and 90%RH or less.

The LEDs should be used within a year.

When storing the LEDs, moisture proof packaging with absorbent material (silica gel desiccants) is recommended.

- After opening the package:

The LEDs should be kept at 30°C or less and 70%RH or less.

The LEDs should be soldered Within 168 hours (7 days) after opening the package. if unused LEDs remain, they should be stored in the moisture proof packages, such as sealed containers with packages of moisture absorbent material (silica gel desiccants). It is also recommended to return the LEDs to the original moisture proof bag and to reseal the moisture proof bag again.

- If the moisture absorbent material (silica gel desiccants) has faded away or the LEDs have exceeded the storage time, baking treatment should be performed using the following condition.

Baking treatment: more than 24 hours at 65°C

- Please avoid rapid transitions in ambient temperature, especially in high humidity environments where condensation can occur.

10. STATIC ELECTRICITY

- Static electricity or surge voltage damages the LEDs.

It is recommended that a wrist band or an anti-electrostatic glove be used when handing the LEDs.

- All devices equipment and machinery must be properly grounded. It is recommended that precautions be taken against surge voltage to the equipment that mounts the LEDs.